

Evo

Meccanismo di apertura per Ante a Ribalta e a Pacchetto, Aperture Oblique e Verticali
Opening Mechanism for Flap and Folding doors, Oblique and Vertical Openings

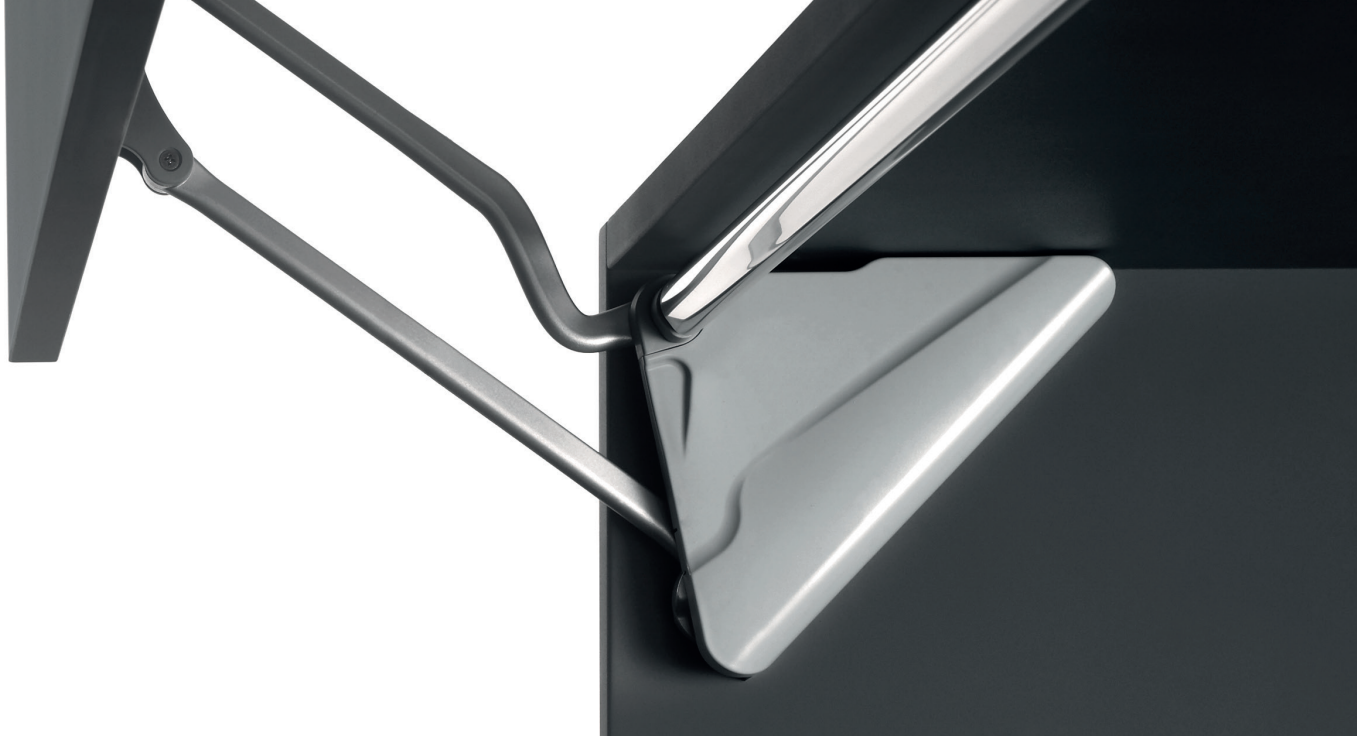



Evo

Meccanismo di apertura per ante basculanti verticali, oblique, a ribalta e a pacchetto, Progettato per mobili modulari:

- Evo O per l'apertura obliqua
- Evo P per ante a pacchetto
- Evo R per ante a ribalta
- Evo V per l'apertura verticale

Per ogni tipologia, è previsto lo stesso schema di foratura.

Evo P per ante a pacchetto è dotato di un meccanismo di sicurezza salvadita. È possibile regolare la forza sia di apertura che di chiusura dell'anta, entrambe ammortizzate permettendo l'uso di ante alte da 32 a 72 cm, portata fino a 17 kg.

Materiali: Acciaio, Zama, Tecnopolimero. Colore: Grigio.

Opening mechanism for oblique and vertical openings and for flap and folding doors. Evo is designed for modular furniture:

- Evo O for oblique opening
- Evo P for folding doors
- Evo R for flap doors
- Evo V for vertical opening

The same drilling scheme is provided for each typology.

Evo P is provided with an anti-trapping system for saving finger. You can adjust the two opening and closing strenghts of the door, both amortized, allowing the use of doors from 32 to 72 cm height up to 17 kg capacity.

Materials: Steel, Zama, Technopolymer. Colour: Grey.

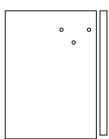

4 meccanismi, 1 schema di foratura
4 mechanisms, 1 drilling pattern

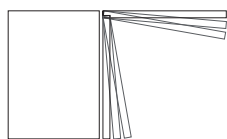

Apertura e chiusura ammortizzate
Opening & closing damping function

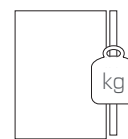

Peso massimo anta 17 kg
Door's max weight 17 kg

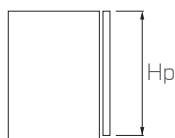

Ante da 32 fino a 72 cm
Door's height from 32 to 72 cm

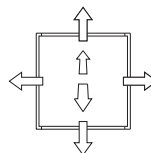

Regolazione orizzontale, verticale e frontale
Horizontal, vertical and frontal adjustment

Per informazioni riguardanti quantità minime ordinabili e colori personalizzati rivolgersi a: info@effegibrevetti.com.

For information about minimum order quantities and custom colors please contact: info@effegibrevetti.com.

Foratura spalla e ingombri
Side panel drilling & overall dimensions

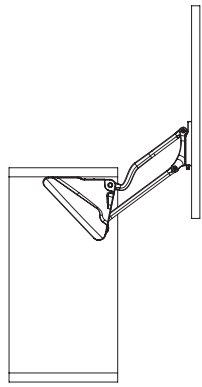

Evo V

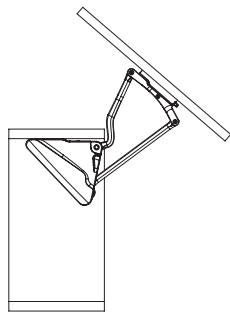

Evo O

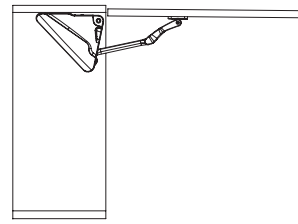

Evo R

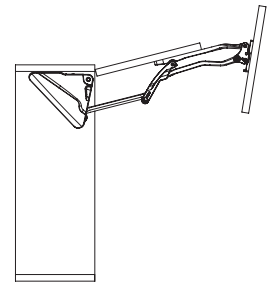

Evo P

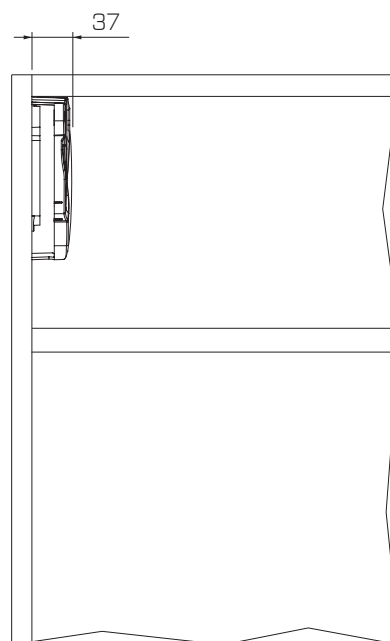
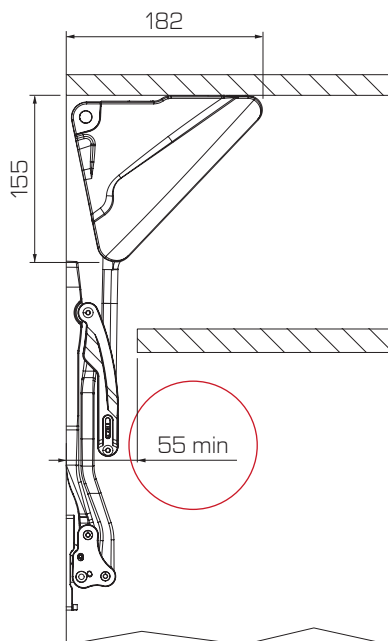
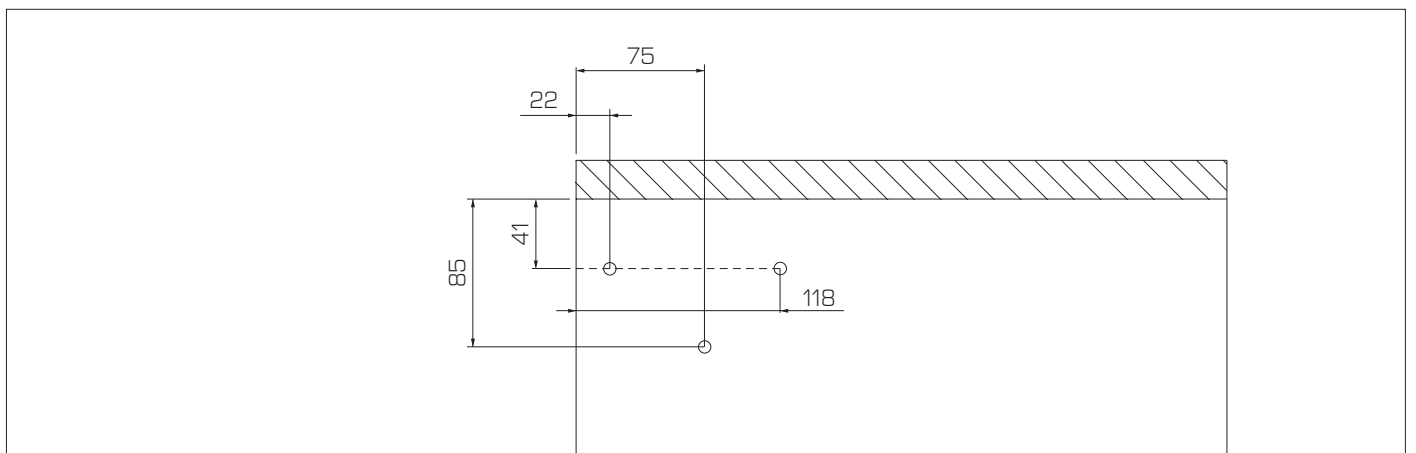

ATTENZIONE - WARNING

Spazio necessario alla chiusura del braccio
Space required for the closing of the arm

Caratteristiche e accessori

Features & accessories

	Evo V	Evo O	Evo R	Evo P
Tipologia di apertura Opening typology	Verticale Vertical	Obliquo Oblique	A ribalta Flap opening	Pieghevole a pacchetto Folding
Dimensioni interne mobile Cabinet inner dimensions	Hi = 277 - 402 mm L = 300 mm min. P = 182 mm min.	Hi = 372 mm min. L = 300 mm min. P = 182 mm min.	Hi = 276 mm min. L = 300 mm min. P = 182 mm min.	Hi = 400 - 925 mm L = 300 mm min. P = 182 mm min.
Regolazioni anta Door adjustments	± 2 ± 2 ± 2	± 2 ± 2 ± 2	± 2 ± 2 ± 2	± 2 ± 2 ± 2
Cerniera consigliata Suggested hinge	A scelta Free choice	A scelta Free choice	Cerniera 90° con molla 90° hinge with spring	Cerniera 110° con molla 110° hinge with spring
Peso massimo anta Max door weight	17,7 kg	15,3 kg	19,9 kg	15,4 kg
Barra di collegamento Connecting bar	✓	✓	✗	✗
Regolazione forza apertura Opening force adjustment	✓	✓	✓	✓
Chiusura ammortizzata regolabile Adjustable soft closing mechanism	✓	✓	✓	✓

Barra di collegamento

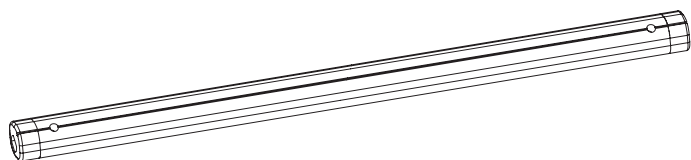

Connecting bar



L	Cod.
600	EVRRO600090
900	EVRRO900090
1200	EVRR1200090
1500	EVRR1500090
1800	EVRR1800090

Kit vetro

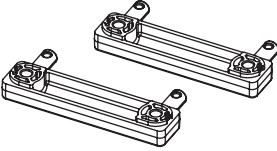
Glass kit

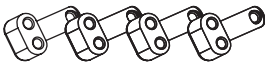
	Evo	Cod.
	Evo V Evo O Evo P	EVXVT70XX04
	Evo R	EVXVTUXXX36
	2 Evo R KIT	EVXVTUSET36

Regolazione forza e velocità di apertura dell'anta
Door's opening strenght and speed adjustment

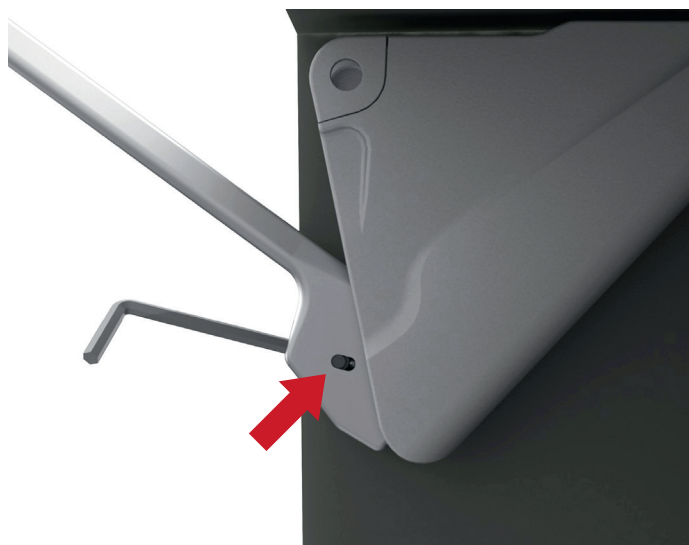

Min

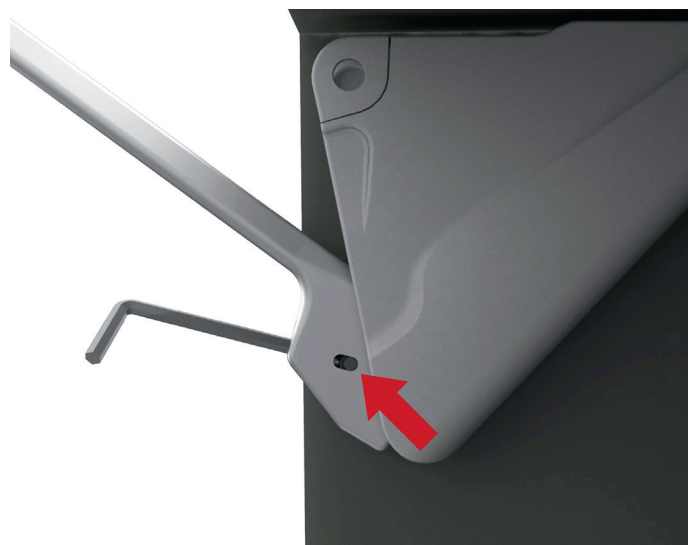

Max

Utensile: chiave esagonale 5 mm
Tool: 5 mm Allen key

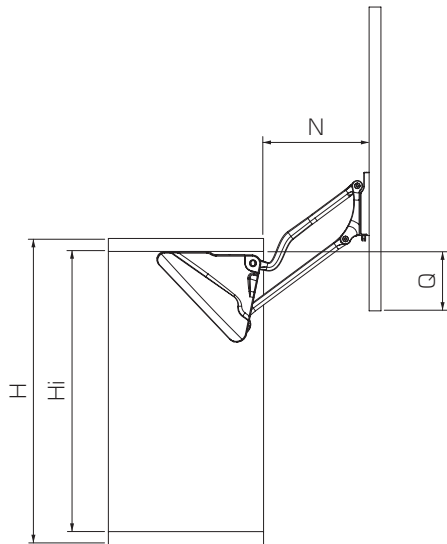

Foratura anta
Door drilling

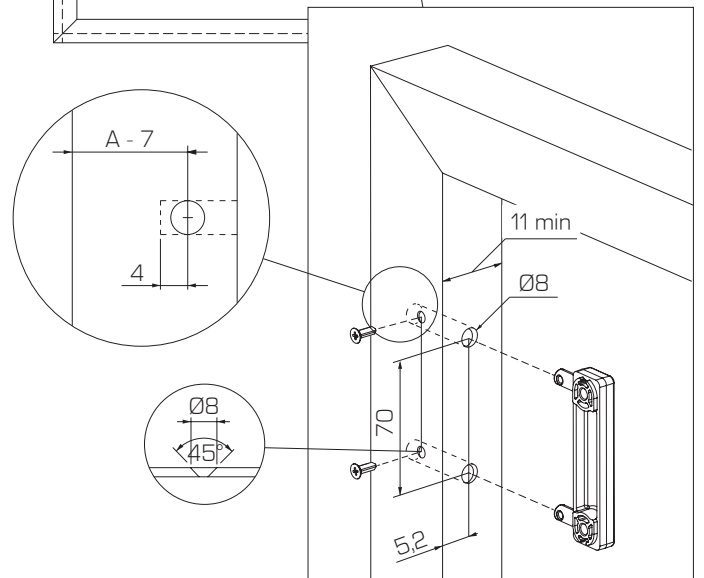
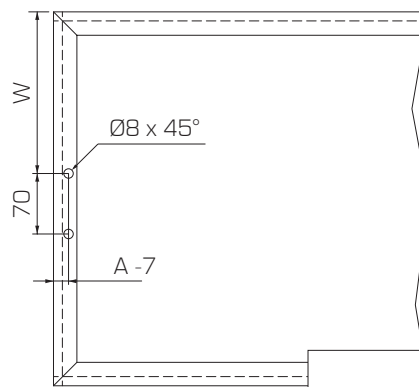
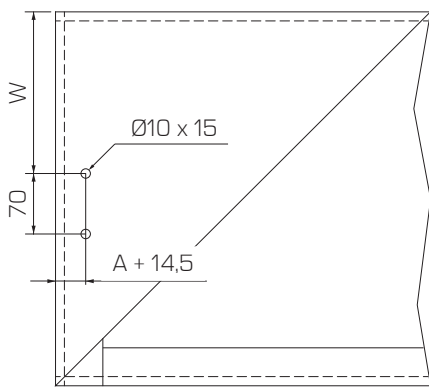

H	Hi	N	Q	W
320	277 min	126	49	160 + B
360	312 min	155	33	195 + B
390	342 min	179	15	225 + B
440	372 min	203	17	255 + B
480	402 min	227	9	285 + B

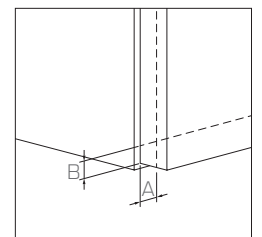

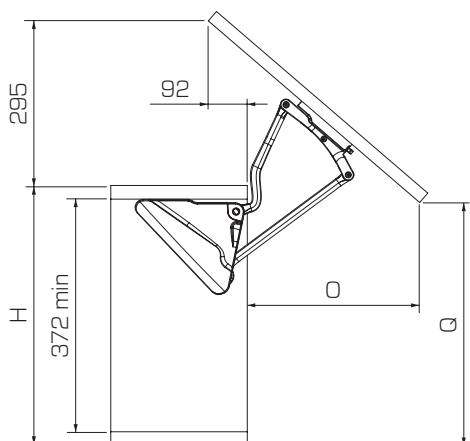

Foratura anta
Door drilling

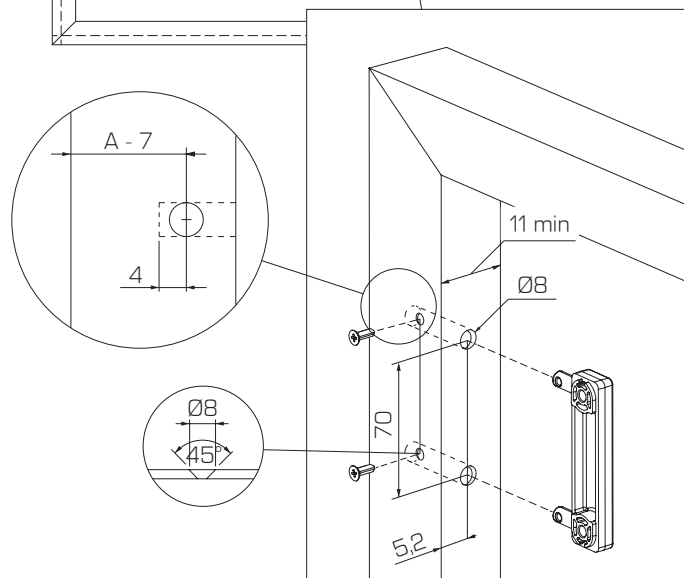
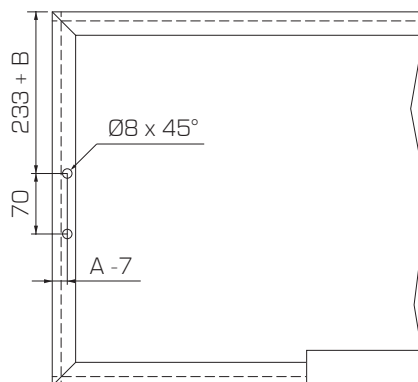
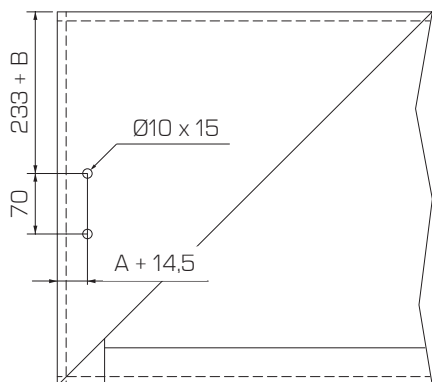

H	Q	O
440	450	234
540	484	309
600	504	354
720	545	446

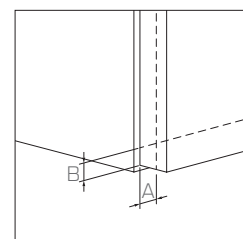

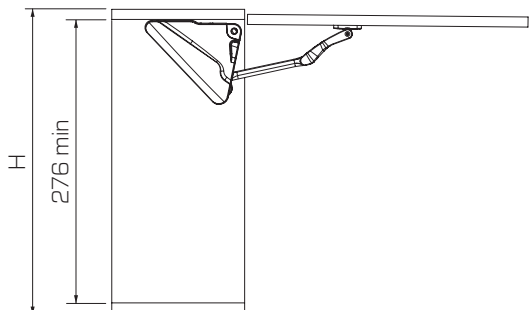

Foratura anta
Door drilling

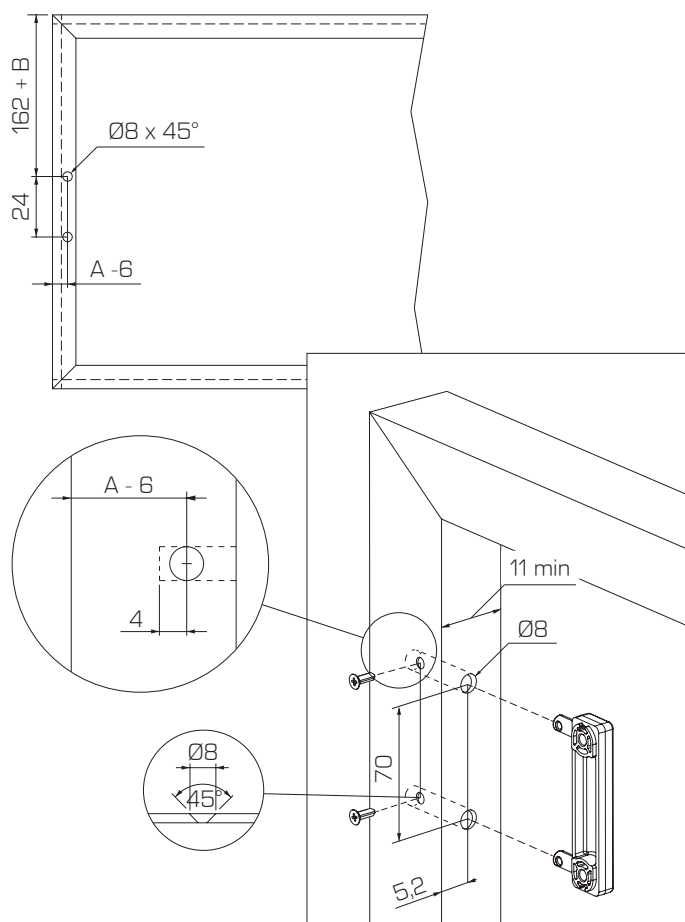
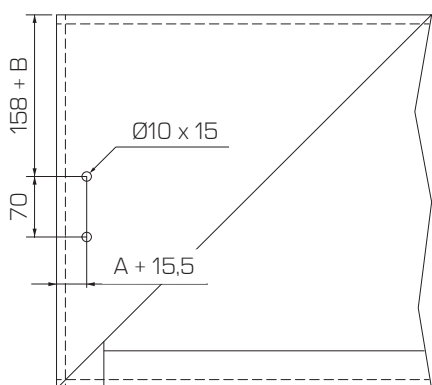

H
360
480
540
600
720

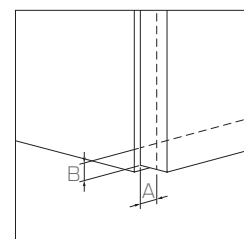

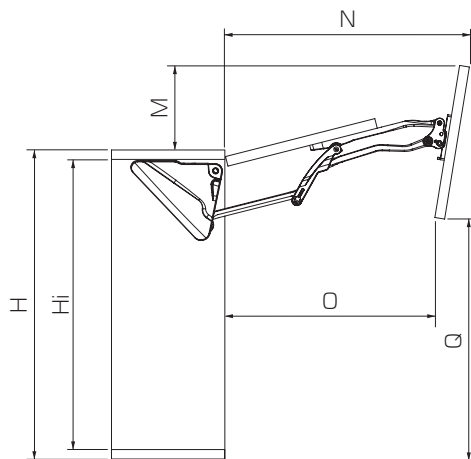

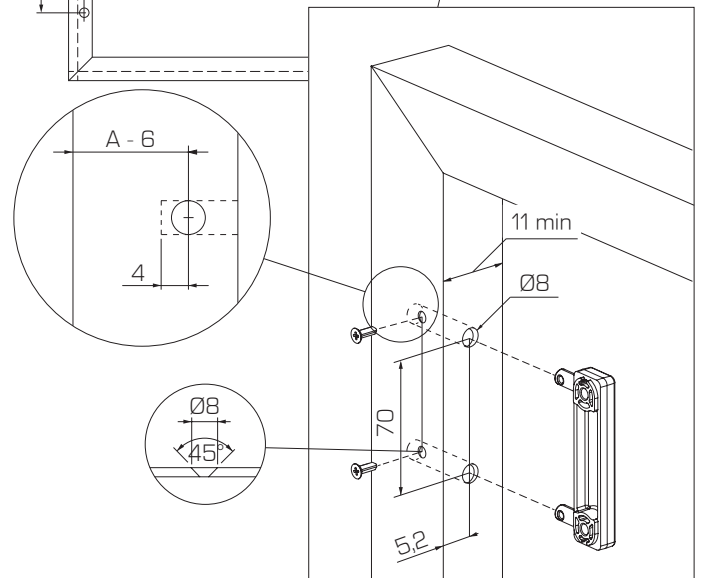
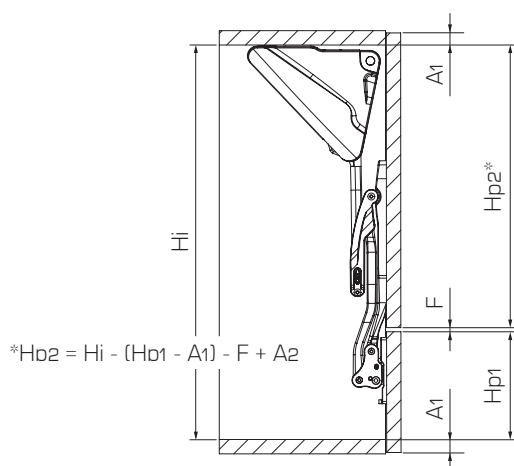
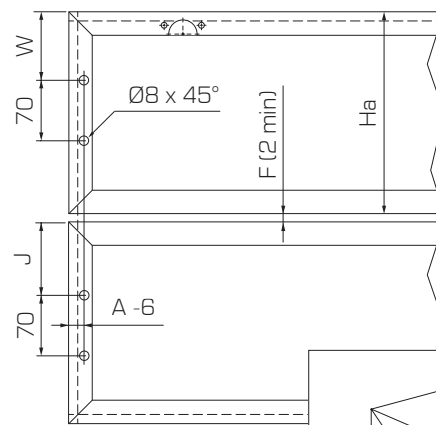
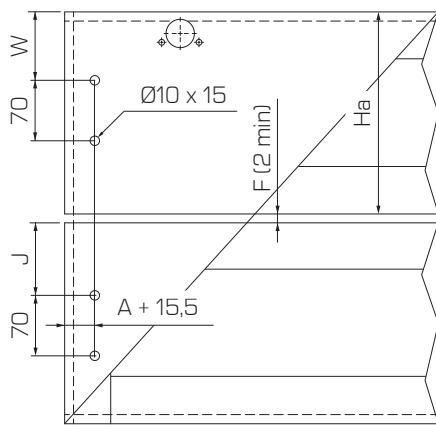

Foratura anta
Door drilling



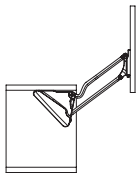
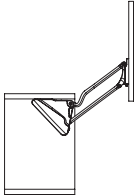
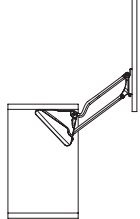
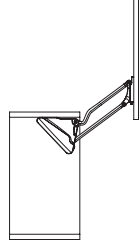
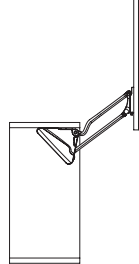

H	Hi	M	Q	N	O	W	J	Hp1 min	Hp1 max
480	440 - 550	179	430	440	383	B + 120	351 - (Ha - B + F)	-	-
600	550 - 610	163	468	474	404	B + 155	386 - (Ha - B + F)	A1 + 262	A1 + 346
720	610 - 700	141	506	494	418	B + 185	416 - (Ha - B + F)	A1 + 292	A1 + 376
800	700 - 770	138	544	522	439	B + 215	446 - (Ha - B + F)	A1 + 322	A1 + 406
900	770 - 925	126	582	547	457	B + 245	476 - (Ha - B + F)	A1 + 352	A1 + 436

Tabelle pesi anta
Door weight tables

	320	360	390	440	480
150	2,1 - 3,8	2,3 - 3,8	-	-	-
200	3,8 - 5,4	3,6 - 5,3	2,1 - 4,8	1,7 - 3,8	-
250	5,6 - 7,1	5,2 - 7,1	3,3 - 6	2,6 - 5	3,2 - 4,9
300	7,3 - 8,8	6,5 - 8,7	4,3 - 7,2	3,8 - 6,3	4,4 - 5,9
350	8,9 - 10,5	7,9 - 10,2	5,5 - 8,6	4,9 - 7,5	5,4 - 6,8
400	10,6 - 12,1	9,1 - 11,7	6,6 - 9,7	6 - 8,7	6,3 - 7,8
450	-	10,5 - 13,2	7,8 - 10,9	7,1 - 9,9	7,3 - 8,7
500	-	11,6 - 14,7	8,9 - 12,2	8,2 - 11,1	8,2 - 9,6
550	-	12,8 - 16,2	10 - 13,4	9,3 - 12,4	9,1 - 10,4
600	-	14,2 - 17,7	11,2 - 14,6	10,5 - 13,6	10,1 - 11,4
650	-	-	12,5 - 15,9	11,7 - 14,9	11,1 - 12,4

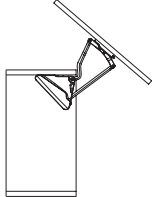
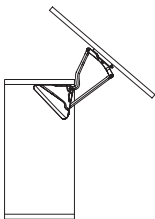
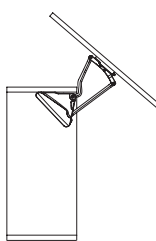
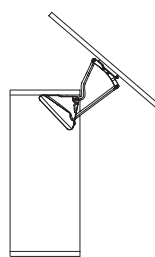





	440	540	600	720
200	3 - 4,4	3,2 - 4,3	2,5 - 3,9	-
250	4 - 5,4	4,2 - 5,4	3,4 - 5,2	3,2 - 4,8
300	5,3 - 6,7	5,2 - 6,5	4,4 - 6,4	4 - 6,1
350	6,3 - 7,9	6,3 - 7,4	5,4 - 7,4	4,9 - 7,1
400	7,7 - 9,1	7,3 - 8,6	6,5 - 8,4	5,8 - 8,2
450	8,8 - 10,3	8,4 - 9,9	7,5 - 9,5	6,8 - 9,1
500	10 - 11,5	9,4 - 10,9	8,5 - 10,5	7,7 - 10
550	11 - 12,6	10,5 - 12,1	9,6 - 11,6	8,6 - 11,6
600	12,1 - 13,8	11,6 - 13,2	10,7 - 12,6	9,6 - 13
650	13,3 - 14,9	12,6 - 14,2	11,7 - 13,7	10,5 - 13,5
700	-	13,6 - 15,3	12,8 - 14,7	11,4 - 14,3



	360		480		540		600		720	
	EVO x1	EVO x2	EVO x1	EVO x2	EVO x1	EVO x2	EVO x1	EVO x2	EVO x1	EVO x2
150	1,1 - 2,4	2,1 - 4,7	1 - 1,9	2 - 3,8	-	-	-	-	-	-
200	2,1 - 3,5	4,1 - 7	1,7 - 2,7	3,3 - 5,4	1,2 - 2,5	2,4 - 4,9	-	-	-	-
250	3,1 - 4,5	6,1 - 8,9	2,3 - 3,2	4,5 - 6,3	1,9 - 3,1	3,8 - 6,2	1,9 - 2,8	3,8 - 5,6	1,9 - 2,5	3,8 - 5
300	3,9 - 5,4	7,8 - 10,7	2,8 - 4	5,7 - 7,9	2,6 - 3,8	5,2 - 7,6	2,5 - 3,4	4,9 - 6,7	2,2 - 3	4,4 - 5,9
350	4,9 - 6,2	9,7 - 12,4	3,6 - 4,7	7,1 - 9,3	3,3 - 4,5	6,6 - 9	3,1 - 3,9	6,1 - 7,7	2,7 - 3,4	5,4 - 6,8
400	5,8 - 7,2	11,5 - 14,3	4,3 - 5,4	8,6 - 10,7	4,1 - 5,2	8,1 - 10,3	3,6 - 4,4	7,2 - 8,8	3,2 - 3,9	6,3 - 7,8
450	6,7 - 8	13,3 - 16	5,1 - 6,1	10,2 - 12,1	4,9 - 5,8	9,7 - 11,6	4,2 - 5	8,4 - 10	3,7 - 4,4	7,3 - 8,7
500	7,6 - 8,9	15,2 - 17,9	5,9 - 7,7	11,7 - 13,4	5,5 - 6,4	11 - 12,8	4,8 - 5,5	9,6 - 11	4,1 - 4,8	8,2 - 9,6
550	-	-	6,5 - 7,2	12,9 - 14,3	6,2 - 7,1	12,4 - 14,1	5,4 - 6,1	10,7 - 12,2	4,6 - 5,2	9,1 - 10,4
600	-	-	7,1 - 7,8	14,2 - 15,5	6,9 - 7,7	13,7 - 15,4	6 - 6,6	12 - 13,2	5,1 - 5,7	10,1 - 11,4
650	-	-	7,7 - 8,4	15,4 - 16,8	7,5 - 8,4	15 - 16,7	6,6 - 7,2	13,1 - 14,3	5,6 - 6,2	11,1 - 12,4



	480	600	720	800	900
	300	4,4 - 5,8	4 - 6	-	-
350	5,1 - 6,6	4,5 - 6,7	3,8 - 5,8	4 - 5,2	-
400	6 - 8	5,3 - 7,6	4,6 - 7	4,6 - 5,9	4 - 5,5
450	6,8 - 9,2	6,2 - 8,6	5,9 - 8	5,3 - 6,7	4,9 - 6,5
500	7,8 - 10,2	7 - 9,3	6,9 - 8,9	5,9 - 7,4	5,5 - 7
550	8,9 - 11,2	8 - 10,3	8 - 9,9	6,7 - 8,3	6 - 7,7
600	10,5 - 12,6	9,1 - 11,4	8,8 - 10,8	7,8 - 9,3	6,9 - 8,7
650	12,2 - 14,2	10,5 - 12,6	10,1 - 12	8,5 - 10,4	7,9 - 9,8
700	13,2 - 15	11,7 - 13,6	11,1 - 12,9	9,4 - 11,2	8,6 - 10,5
750	13,8 - 15,4	12,3 - 14,1	11,6 - 13,5	10 - 11,8	9,3 - 11
800	-	13,3 - 14,6	12,6 - 14,4	10,8 - 12,7	10,1 - 11,7
850	-	-	13,4 - 15,2	11,8 - 13,6	10,7 - 12,6

Il catalogo di Effegibrevetti contiene:

- Aperture a Ribalta
- Aperture a Pacchetto
- Aperture Verticali
- Aperture Oblique
- Apertura a Pantografo
- Aperture Scorrevoli Complanari
- Aperture Scorrevoli
- Cerniere
- Bussole a Espansione
- Giunti Orizzontali
- Giunti Verticali
- Giunti a Scatto
- Reggipiani
- Livellatori
- Push to Open

*Effegibrevetti ha la facoltà di apportare ai prodotti tutte le modifiche e migliorie tecniche.

Effegibrevetti's catalog contains:

- Flap Openings
- Folding Openings
- Vertical Openings
- Oblique Openings
- Pantograph Openings
- Coplanar Sliding Mechanisms
- Standard Sliding Mechanisms
- Hinges
- Spreading Dowels
- Horizontal Fittings
- Vertical Fittings
- Snap Fittings
- Shelf Supports
- Levellers
- Push to Open

*Effegibrevetti reserve the right to make changes and technical improvements to its products.

EFFEGIBREVETTI

Effegibrevetti S.r.l.

Via Cava Trombetta 17/25
20054 Segrate Milano Italy

Tel +39 02 26921838
Fax +39 02 26921737

info@effegibrevetti.com
www.effegibrevetti.com

**COMPANY WITH
QUALITY SYSTEM
CERTIFIED BY DNV GL
= ISO 9001 =**